

Data Sheet



Article number: 12524800240100

Description: KLEE-coil 524 800 240.100
M4 Hardened, zinc-pl. & chr. yellow

Measures

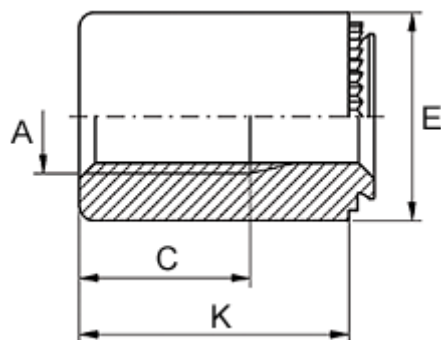

Female thread A	= M4
Height K	= 24
Min distance to edge	= 4.0
Outer diameter E	= 8
Plate thickness	= 1.5 to 2.3
Recommended bore diameter +0.05	= 5.00
Thread length	= 8.0